



MARCUS

Marcus Transformer LTD
 Phone: 1-800-267-7376
 Fax: 1-866-205-7526
 Email: Info@marcustransformer.com

TECHNICAL DATA

SINGLE PHASE CONTROL TRANSFORMER

DESCRIPTION

MODEL	
Type	Epoxy
VA	250
Primary (Volts)	
Secondary (Volts)	
Input/Output Amps	
Temperature Rise	95°C
Insulation Class	B(130°C)
Frequency	60Hz
Polarity	additive
Noise level	less than 40DB
Winding	Copper
Approvals	CSA Approved

MEC SELECTION GUIDE

TYPE	PRIMARY VOLTAGE	SECONDARY VOLTAGE	SUFFIX
MEC-Marcus	A-600	1-120	50Hz-EUR
Single Phase	B-480	2-240	Elec.Shield-S
Epoxy	C-416	3-120/240	
Encapsulated	D-380	4-240/480	
Close Style	E-347		
	F-277		
	G-240		
	H-208		
	I-120		
	J-120/240		
	K-240/480		

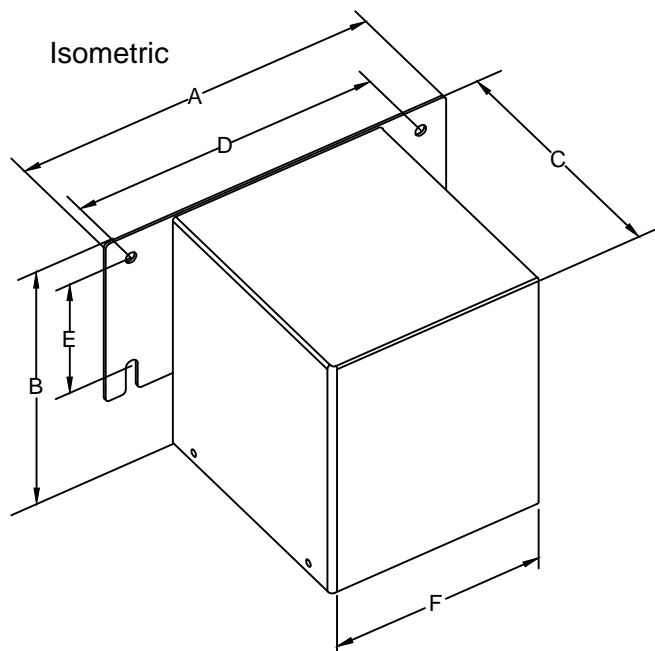

Top View

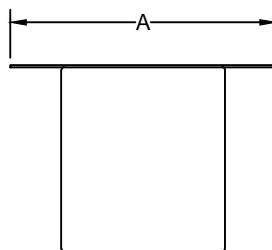

Side View

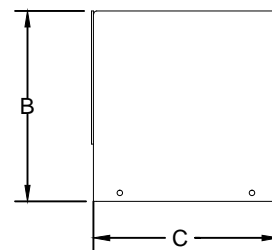

Front View

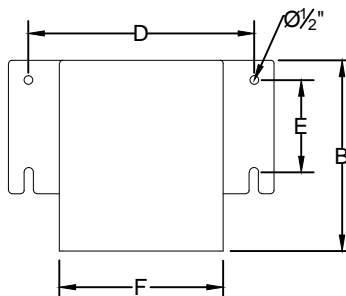

DIMENSIONS INCHES / MM

VA	A	B	C	D (mtg)	E (mtg)	F	SHIP WEIGHT LBS / KG
250	10 254	7.0 178	6.0 152	8.5 216	3.5 89	7.0 178	23 10.4